

K9 S

 megaSun®

 SUNSPHERE PRO

LUMINOUS EFFICIENT DYNAMIC

„Progress is the realization of ideas.“ – Oscar Wilde

With the K7 KBL build the foundation of the K-Series. Captivating design and innovative technologies lead the way for the newest top model K9S. Born from the pen of Etienne Salomé, a designer known for his work for Bugatti automobiles, the K9S completes the K-Series. SunSphere Pro marks a great leap into the future for KBL. The premiere

of UVB-LEDs in a solarium phases out conventional T5 lamps in the face and décolleté area. A smaller overall footprint without compromising interior space compared to our P9S marks another great feature. **K9S is the complete package.**





SUNSPHERE PRO

THE WORLD'S FIRST FULL LED-FACIAL WITH **UVB-LEDs**.



SunSphere Pro Facials



SunSphere Pro UVB-LEDs



Nano Beauty LEDs



SunSphere Pro UVA-LEDs



SunSphere Shoulders



SunSphere Beauty LEDs



SunSphere UVA-LEDs

SunSphere LED-Technology with its specifically developed aspheric glass lenses has been successful and impressive since its introduction with an excellent tanning experience on the face and shoulders. The SunSphere Pro concept builds on existing LED technology and by integrating its specifically developed **UVB-LEDs** and Nano Beauty

LEDs, it even achieves a 10% improvement in tanning performance. This combination of wavelengths paired with perfect illumination of the glass lenses and sustainability thanks to the long-lasting LEDs makes an unmistakable statement. **Luminous. Efficient. Dynamic.**

New features of the K-Series



AirBreeze Technology

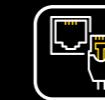

Connectivity



WLAN



AquaCool

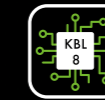

KBL 8



Beauty Booster Pro



3D Soundbar



10" SmartControl



7" SmartControl

SUNSPHERE PRO

AN LED-TECHNOLOGY MORE INDIVIDUAL THAN EVER

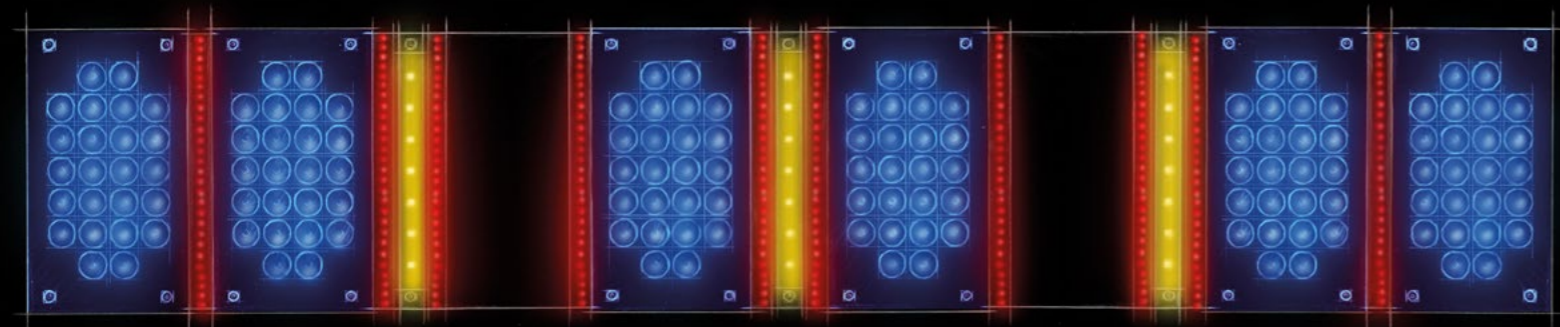

PIGMENT DARKENING

144 UVA LEDs with aspherical lenses

A beautiful tan - just the way you like it. 144 blue UVA-LEDs guarantee the optimum amount of direct pigmentation provided to the face and décolleté.

VITAMIN D

21 UVB LEDs

The 21 yellow UVB-LEDs achieve an optimally balanced build-up of pigment and vitamin D. A completely new tanning sensation.

COLLAGEN DEVELOPMENT

850 Red Nano Beauty LEDs

Red BeautyBooster Pro care for the face and décolleté while tanning and stimulate the oxygen supply in the skin. For a stunning complexion and a velvety-soft skin feeling.



SUNSPHERE PRO

BENEFIT FROM LED-TECHNOLOGY

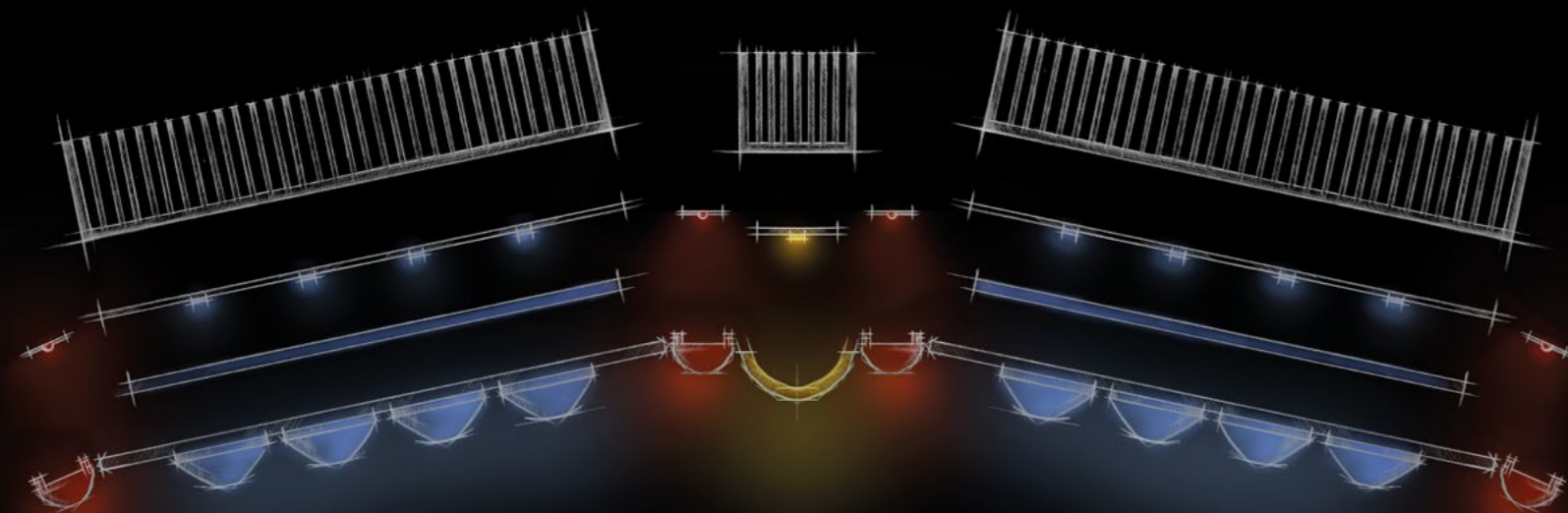

ENERGY
EFFICIENT

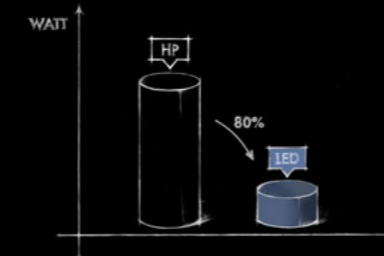

LED-based SunSphere technology from KBL reduces power consumption by up to 80% compared to conventional high-pressure systems using UV lamps.

LONG LASTING
PERFORMANCE

Traditional UV lamps have to be replaced frequently and their performance is greatly reduced over time. In contrast, high-performance LEDs in the SunSphere system last for up to 25 times longer and maintain their consistent output over their entire service life.

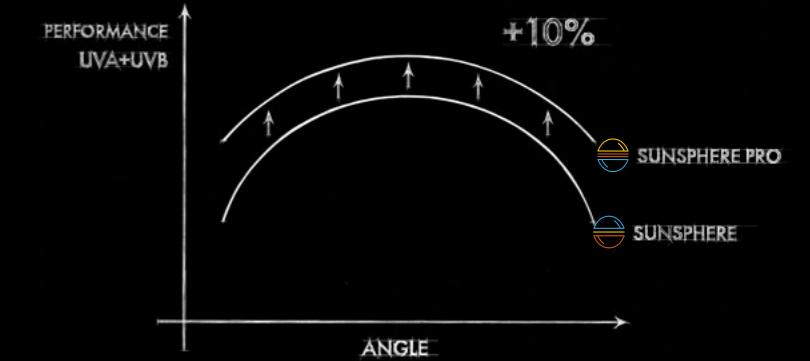
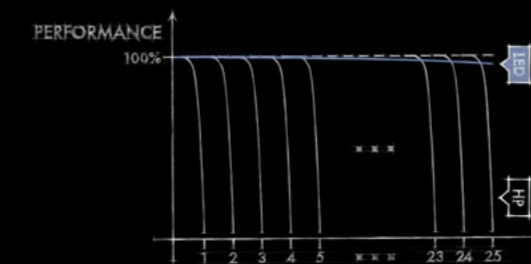

EFFICIENT PERFORMANCE INCREASE

Compared to the proven SunSphere LED technology that provides ideal illumination in the P9S and K-Series, the SunSphere Pro technology in the K9S achieves a 10% better tanning performance.

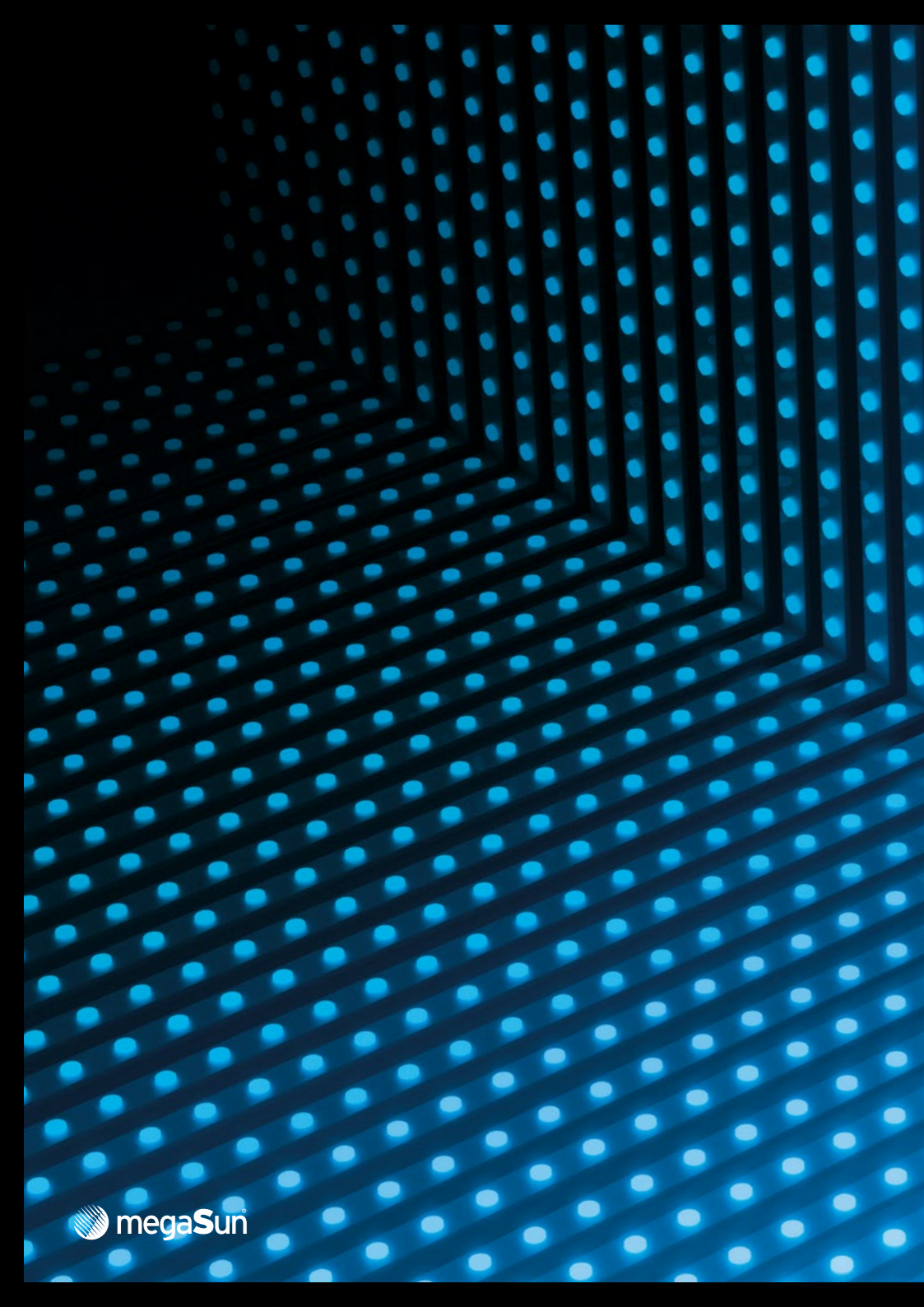

AN IMPRESSIVE DESIGN

The K9S comes with an optical highlight of the K-Series, the Infinity Mirror.

Light effects create a sense of depth that seems to extend to infinity. A magical illusion that never fails to fascinate from any angle.

The new SmartControl display allows the selection of almost unlimited colour combinations of the RGBW LEDs, which adapt perfectly to any environment.

| LED Lighting 

To infinity and beyond.

| Infinity Mirror 

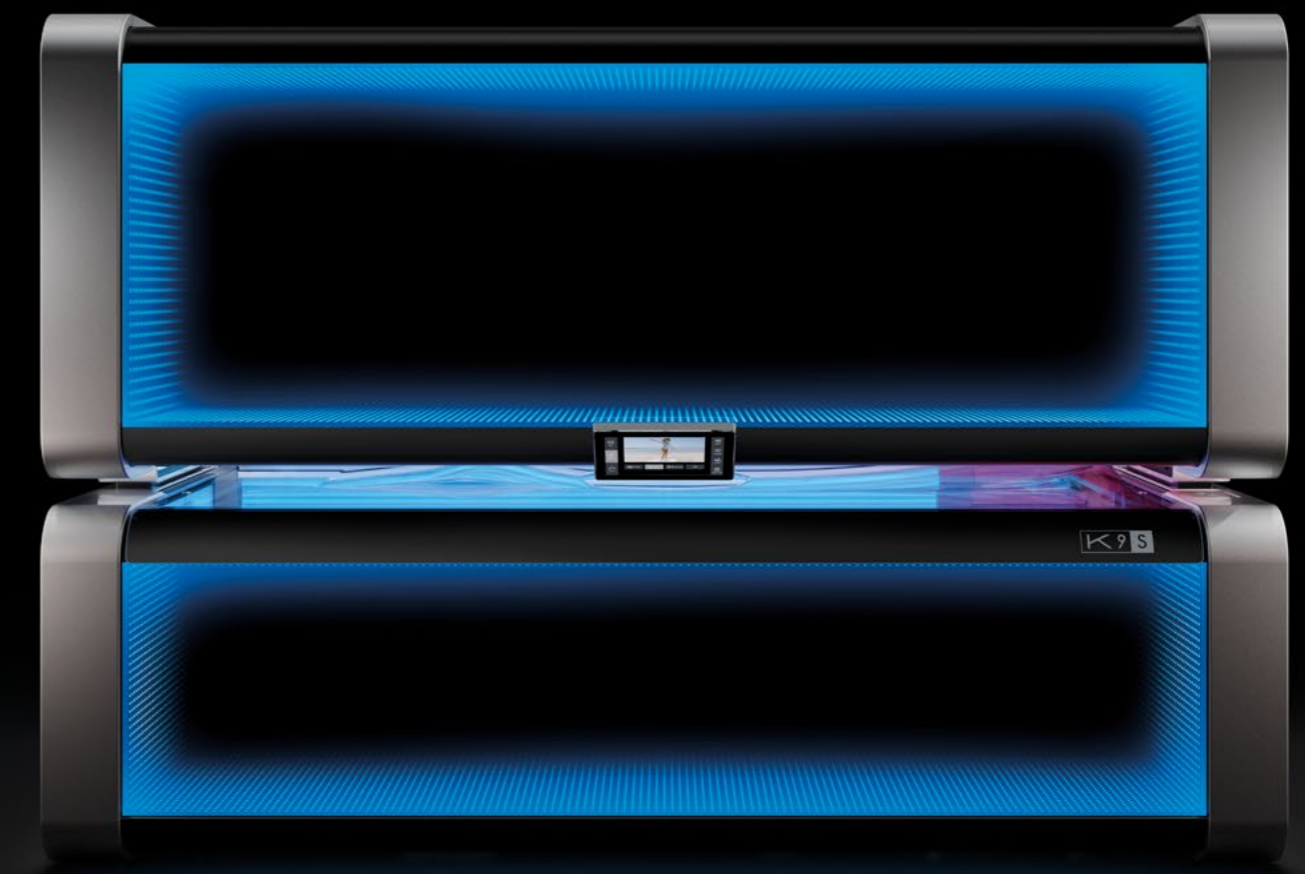



DYNAMIC COLORS

The K9S is available in three matching chassis colors: Magic Silver, Copper Rose and Wonder White.

This color concepts satisfies every wish.



STRIKING OPTICS

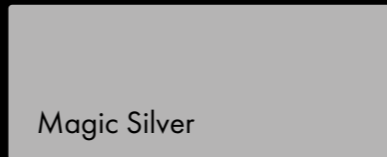

Magic Silver

TRENDSETTER

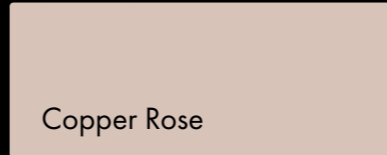

Copper Rose

RADIANT APPEARANCE

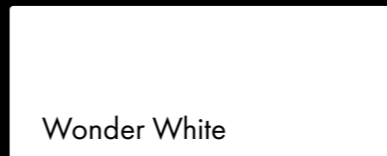

Wonder White

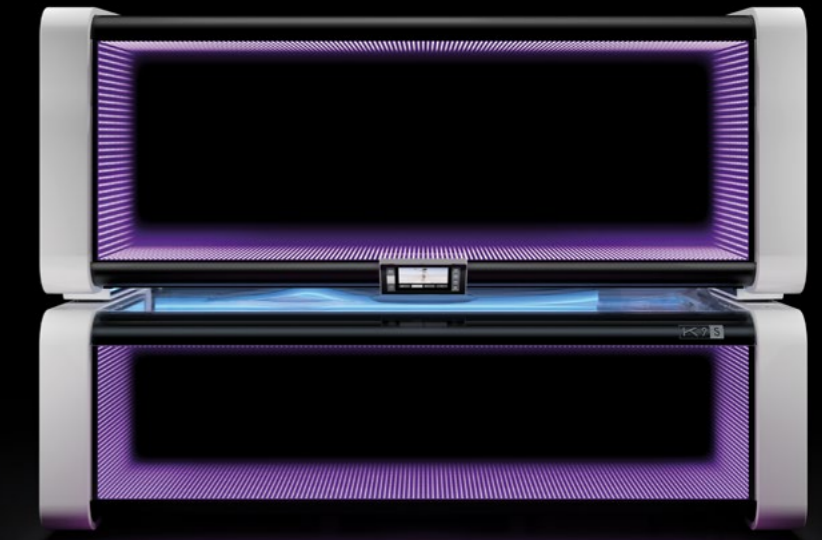

INNOVATIVE TECHNOLOGY

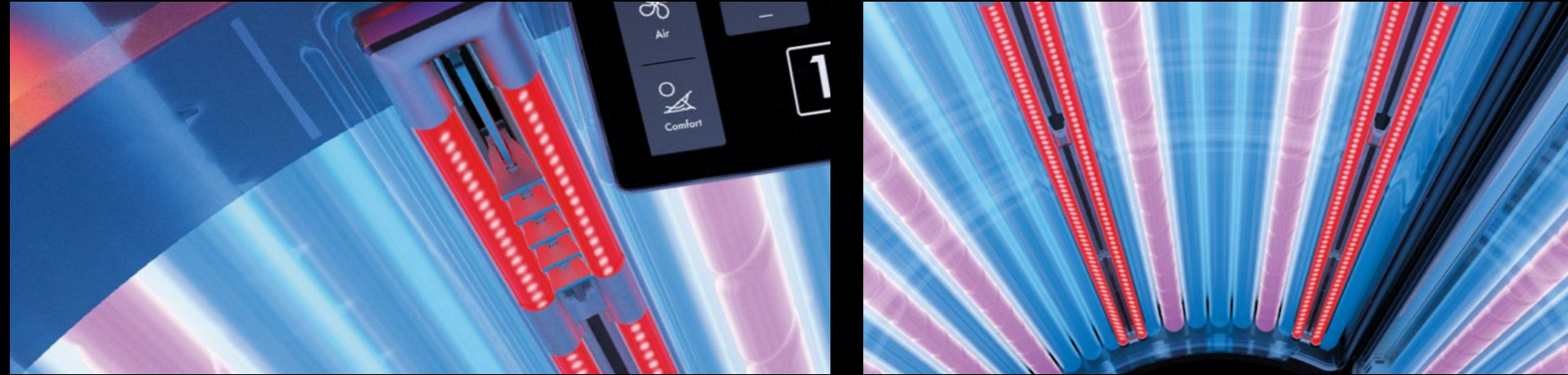

NEW 3-CIRCUIT VENTILATION

Easy to meter AirBreeze technology has been providing draught-free cooling since the K-Series. The individually **adjustable intensity of ventilation** for the body and face now has **separately regulated foot ventilation** in

the K9S. Around the face and décolleté, the air currents can now be pointed in **any direction** you like thanks to the adjustable air nozzles.



Airflow in best shape.

AirPro

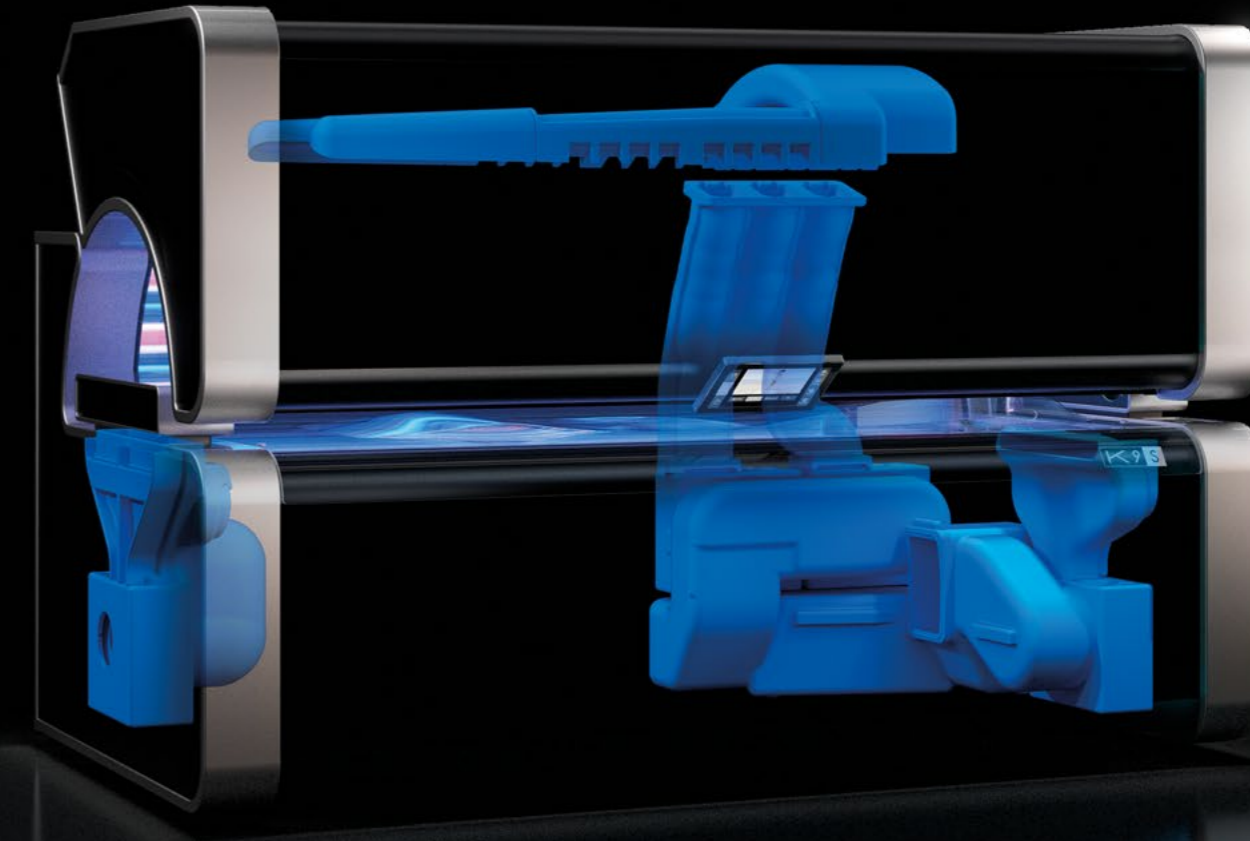

AirBreeze Face



AirBreeze Body



AirBreeze Feet



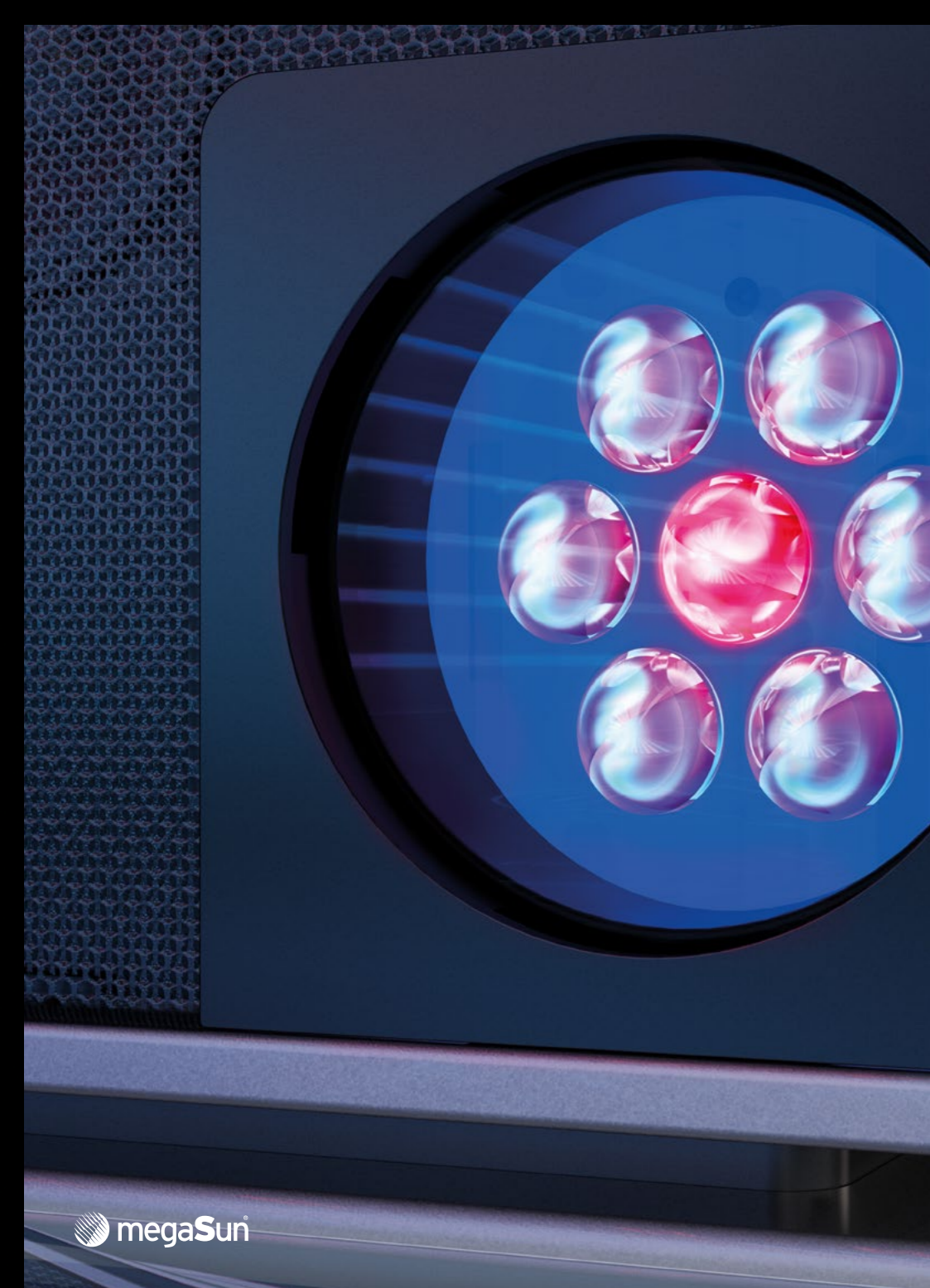

SUNSHINE ALL AROUND

The K9S comes with a SunSphere shoulder tanner as standard for an all-round balanced tanning result. Its 12 UVA-LEDs and two red Beauty-LEDs ensure a flawless complexion. The high-power LEDs and aspheric glass lenses guarantee maximum tanning convenience in the shoulder area.

SunSphere Shoulders

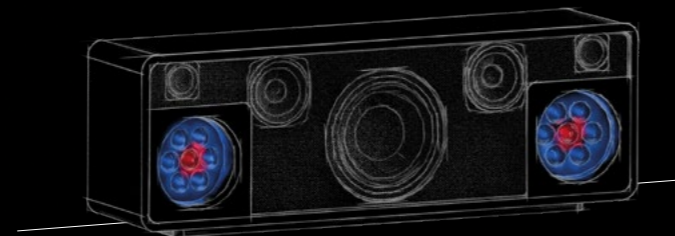

BEAUTIFYING REDLIGHT.

The new K9S is also impressive in terms of skin care:

More than 2.000 red Nano Beauty LEDs evenly distributed over the body provide gentle care for the face, décolleté and body.

With their special wavelength range, they stimulate oxygen supply and natural collagen build-up of the skin. The effect of the Beauty LEDs ensures a healthy complexion and noticeably softer skin.

BeautyBooster Pro

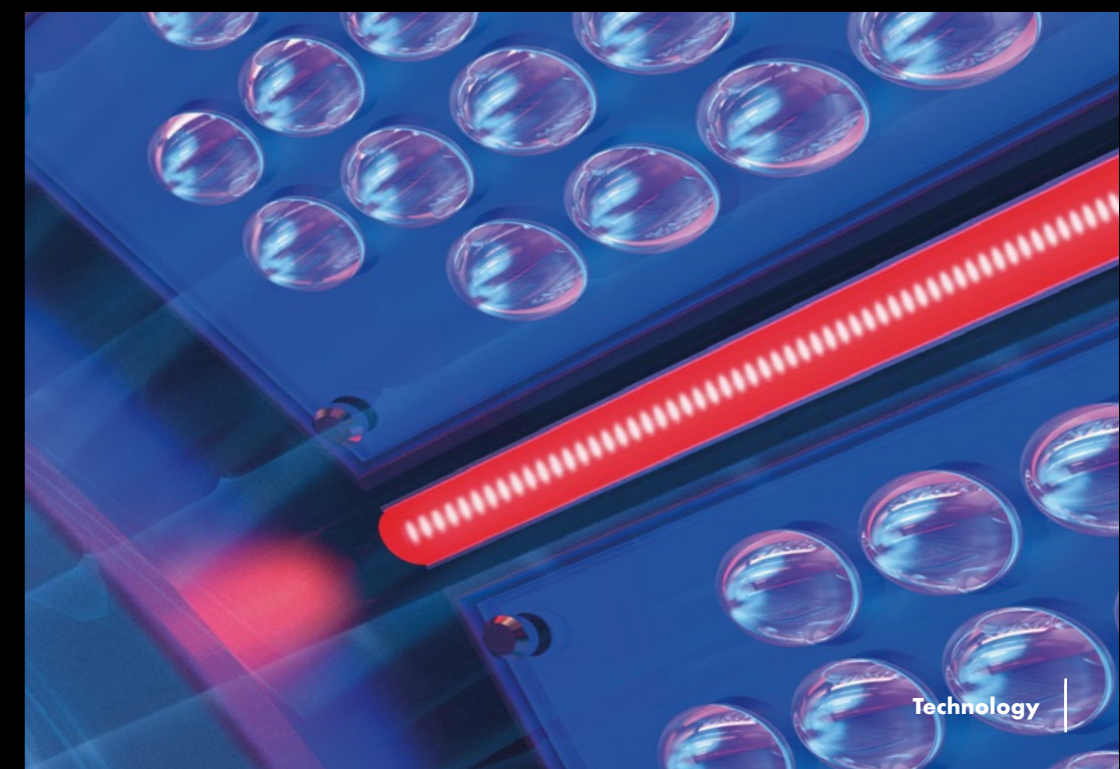
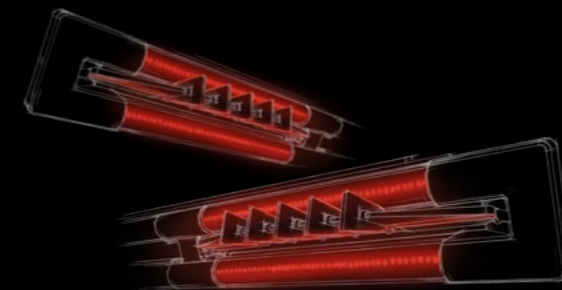



INTUITIVE TOUCH CONTROL

On the outside, all settings for the K9S can be adjusted as usual on a **10" display**, for a relaxing tanning session. Studio owners have the option of access to the new and improved service menu. In **demo mode**, studio staff can project the inner display on to the outer display and provide the customer with a professional introduction to the device.

With the K9S, studio owners can display **customised video clips** with promotional messages on the device.

| 10" SmartControl 

In the interior, all settings can be adjusted quickly and easily while tanning. The modern **color display** switches to an easy-to-read **dark mode** during the tanning session. This enables optimum visibility with all protective goggles.

| 7" SmartControl 

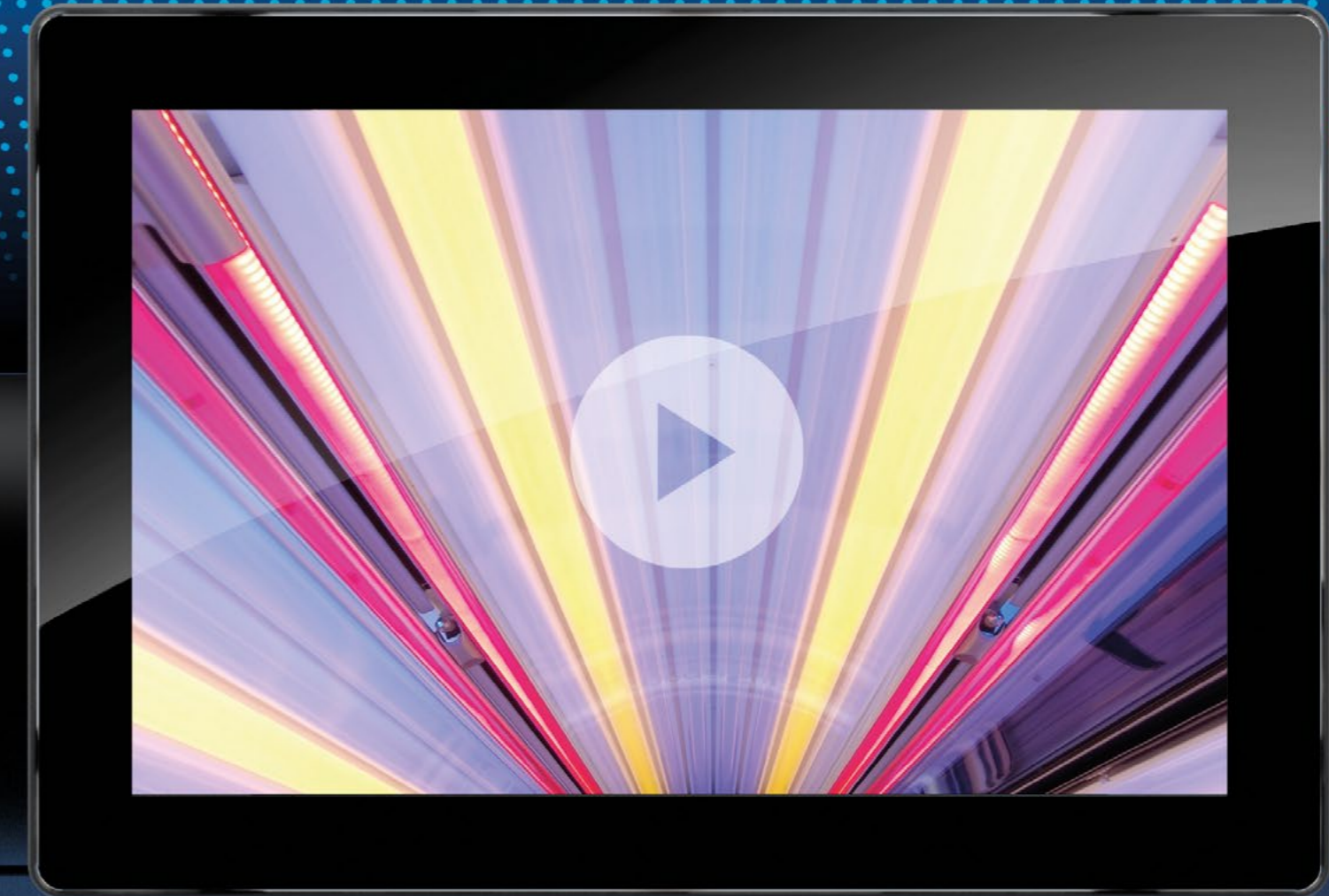

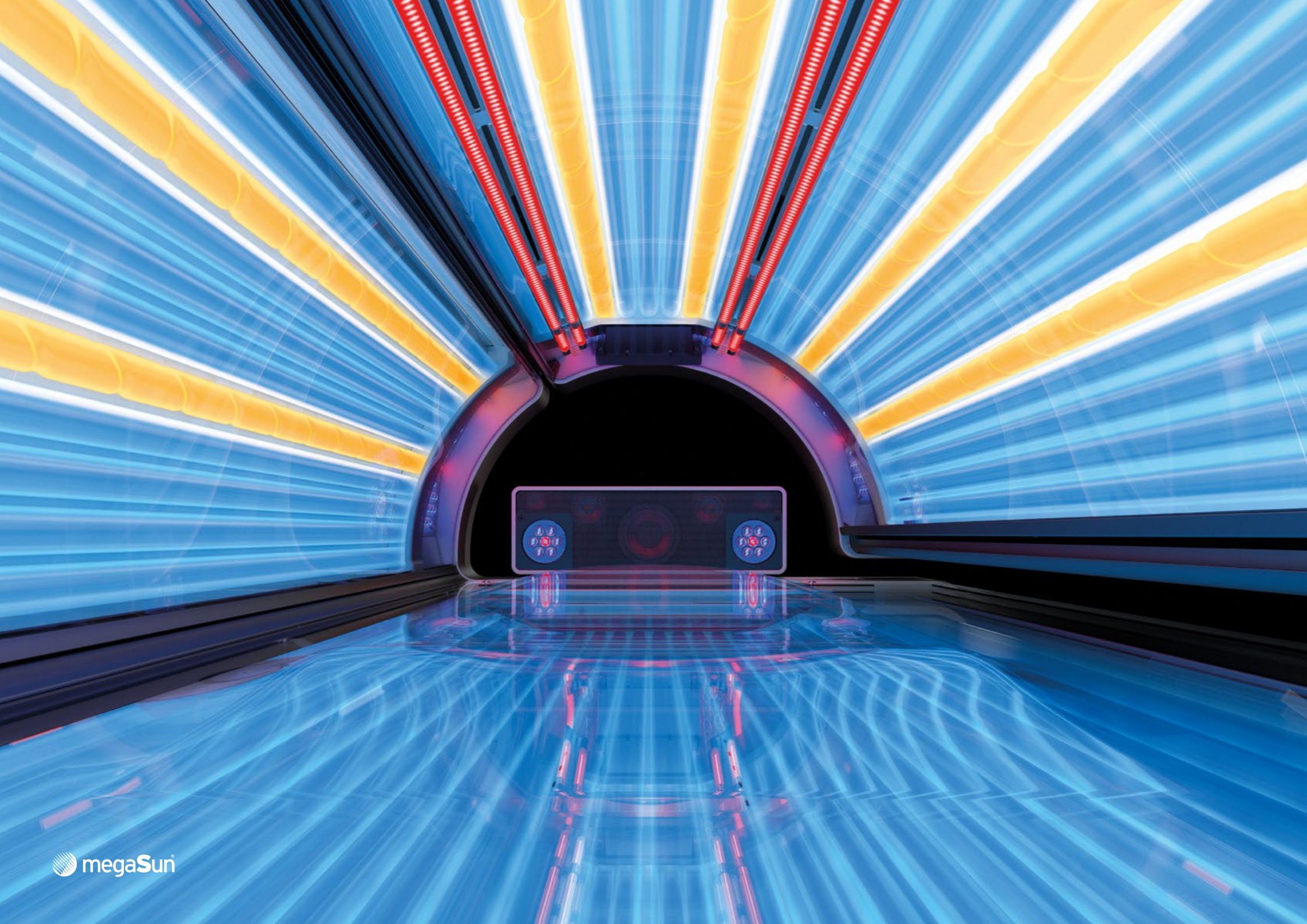

FUTURE PROOF

The heart of K9S is the completely new electronics of the K-Series. It has been entirely redeveloped and relies on current standards and future-oriented technology. With the connectivity package, the K9S offers a networking option that in addition to software updates, will also support remote diagnostics and other features in the future.

- WLAN & Connectivity  
- KBL 8 

AMAZING SOUND

The K9S **3D Soundbar** provides crystal-clear highs, powerful mids and rich bass in the tanning tunnel. Optimally controlled by a digital sound processor. Solarium users can choose between music or, for the first time, relaxation sounds. They can also listen to their own playlists via Bluetooth.

- 3D Soundbar 

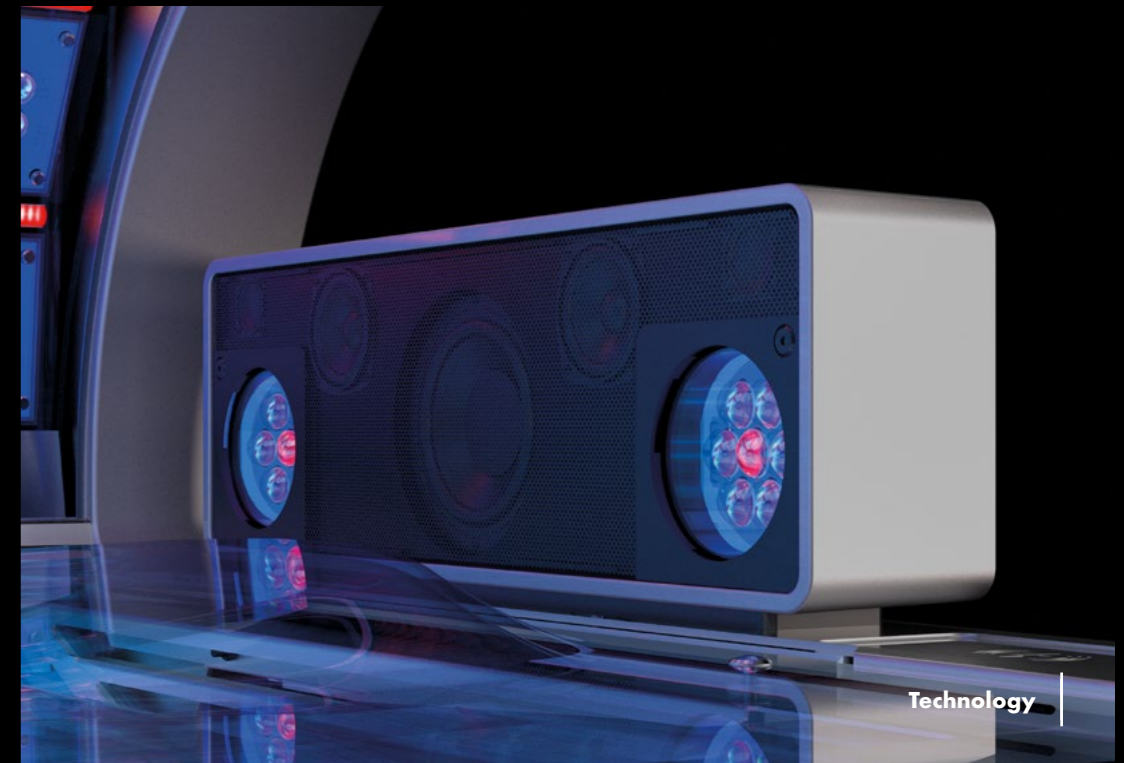



RELAX & ENJOY

Unique relaxation is provided not only by **AirCondition** but also by the individually adjustable dosage of the invigorating **AquaCool mist**. **Scented air** creates a unique fragrance experience, inspiring pleasure for all the senses. Users can completely relax during their tanning session and unwind from the daily grind.



ENERGIZE YOUR PHONE

The inductive energy transfer is an ideal complement to its Bluetooth function. **Wireless Charging** for all suitable smartphones. Simply place the mobile phone in the mould in the surface and it will be charged. This allows your customers to recharge their body, mind and mobile phone at the same time.

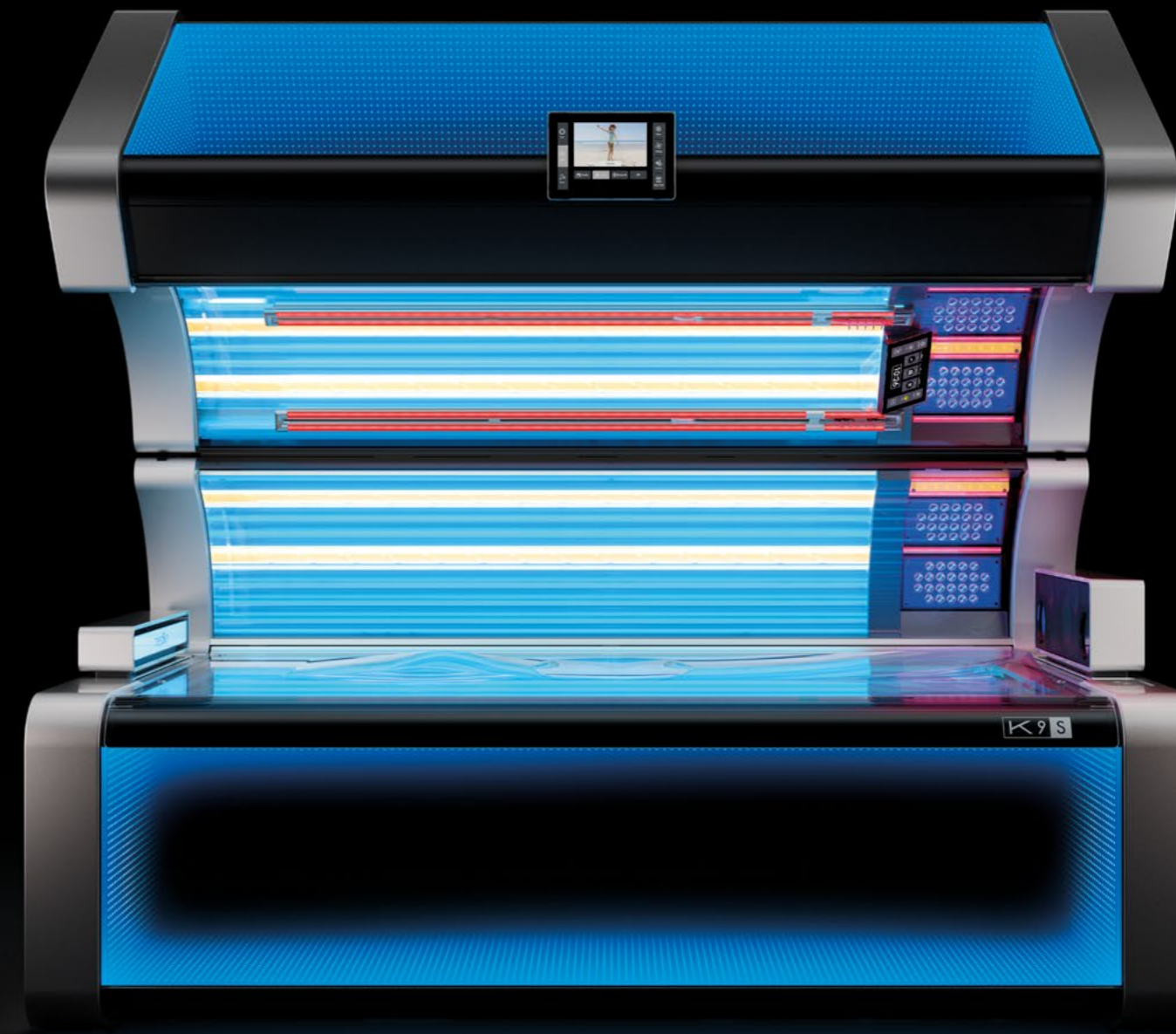

LIGHTSELECT CONFIGURATION



pureSunlight

Intensive sunlight for ideal tanning results.



extraSunlight

Sunlight with high UVB content for pigment development and vitamin D production.



blueSunlight

Activating blue light prepares the skin for a tanning session.



smartSunlight

Intensive sunlight combined with soothing beauty light.



SunSphere Pro Facials

Perfectly balanced spectrum of UVA-LEDs, Nano Beauty-LEDs and UVB-LEDs



SunSphere Shoulders

Balanced spectrum of UVA- and Beauty-LEDs.

vitaSun

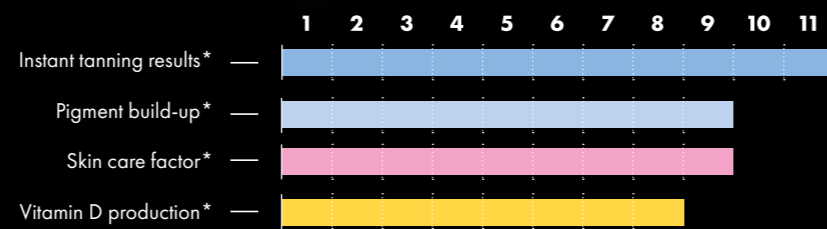

*Exemplary comparative depiction

hybridSun

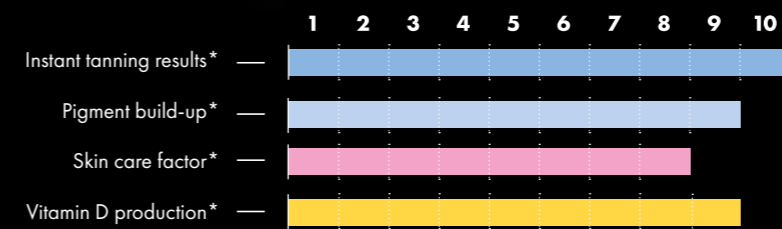

*Exemplary comparative depiction

extraSun

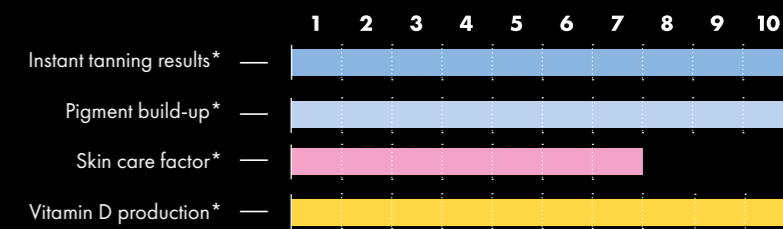

*Exemplary comparative depiction

LIGHTSELECT - CHOOSE THE ONE



pureSunlight

Intensive sunlight for ideal tanning results.



extraSunlight

Sunlight with high UVB content for pigment development and vitamin D production.



blueSunlight

Activating blue light prepares the skin for a tanning session.



smartSunlight

Intensive sunlight combined with soothing beauty light.



SunSphere Pro Facials

Perfectly balanced spectrum of UVA-LEDs, Nano Beauty-LEDs and UVB-LEDs



SunSphere Shoulders

Balanced spectrum of UVA- and Beauty-LEDs.

vitaSun

27



12 13



6



2



> 1000 Nano Blue LEDs

> 1000 Nano Beauty LEDs

hybridSun

32



20



6



2



> 2000 Nano Beauty LEDs

extraSun

46



6



6



2



> 2000 Nano Beauty LEDs

Lightselect

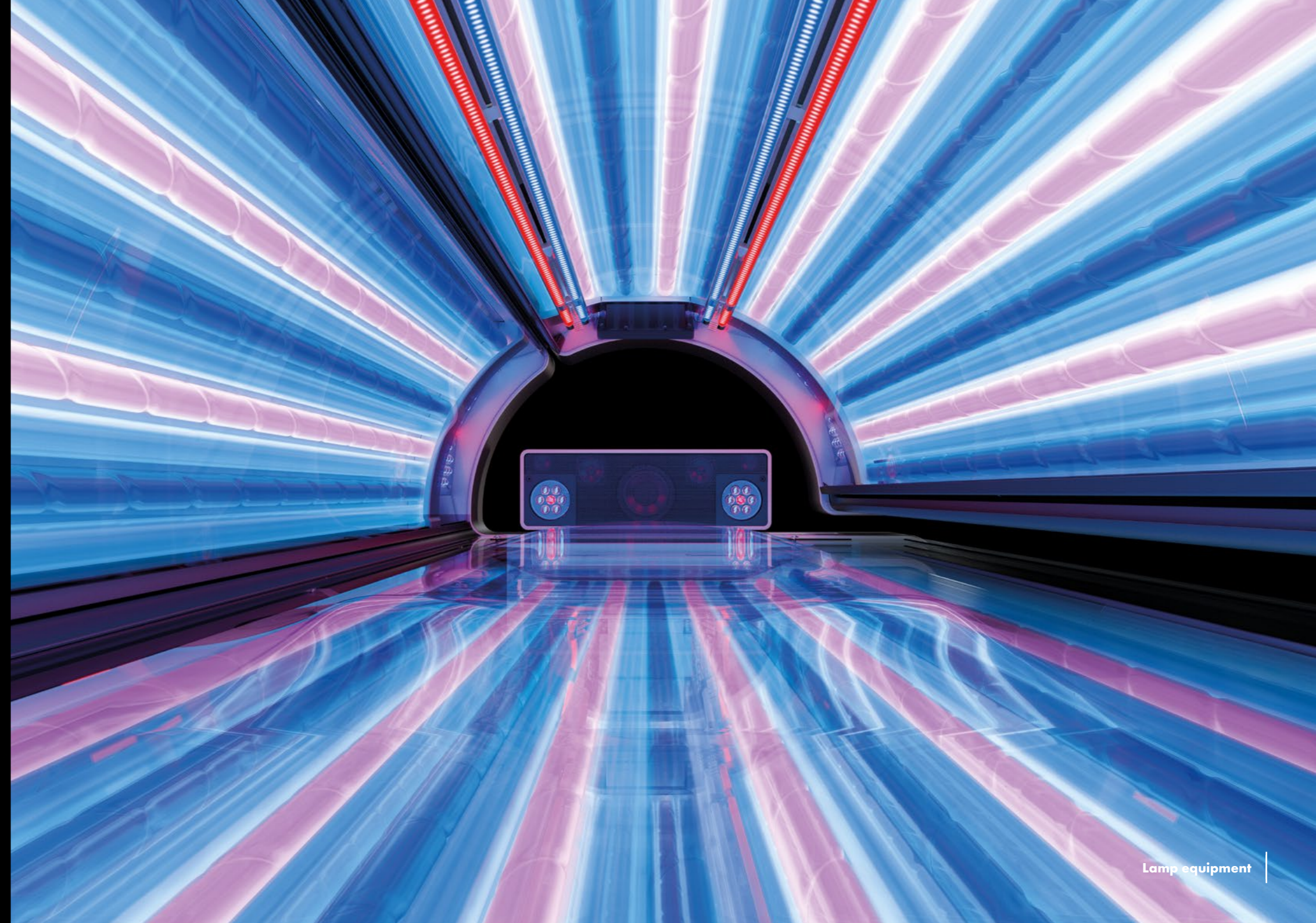

COLORFUL SUMMER VIBES

For maximum tanning performance across three spectral ranges. The new blueSunlight activates the skin and enhances the effects of red light and UV. In addition, it utilizes the visible range above 400nm to achieve even better direct pigmentation. The result: a natural looking tan and increased vitality.



SunSphere Pro
Facials



SunSphere Pro
Shoulders



SUNSPHERE PRO

BLUE LED_s ACTIVATE IN THE UV CONFIGURATION VITASUN

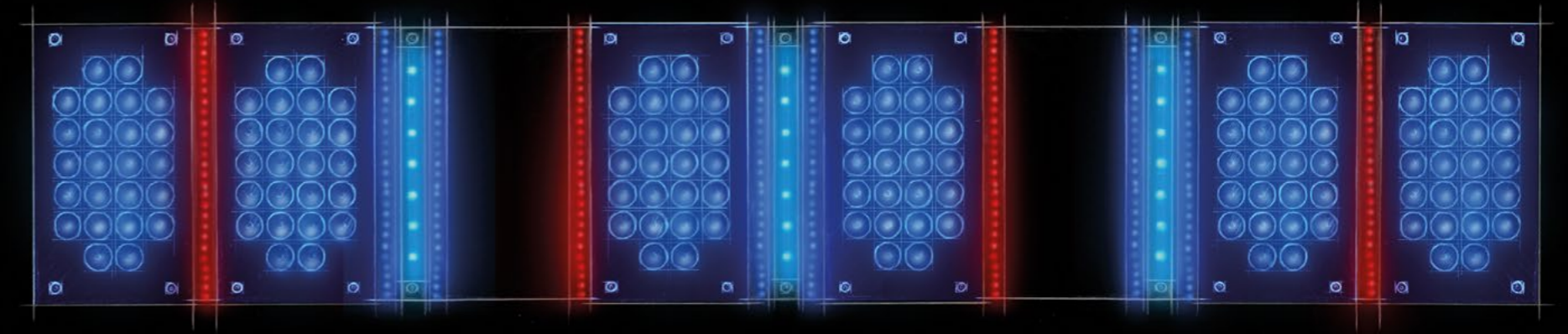

In the facial area of the K9S, the activating effect of blueSunlight is also introduced. SunSphere Pro in the vitaSun configuration replaces half of the red Nano Beauty LEDs with Blue Nano LEDs. In addition, the new UVB-LEDs have a blue tone. The result is an excellent natural looking tan.



SunSphere Pro
UVA-LEDs



Nano
Beauty LEDs

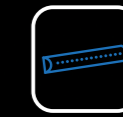

Blue Nano
LEDs



SunSphere Pro
UVB-LEDs

TECHNICAL DATA

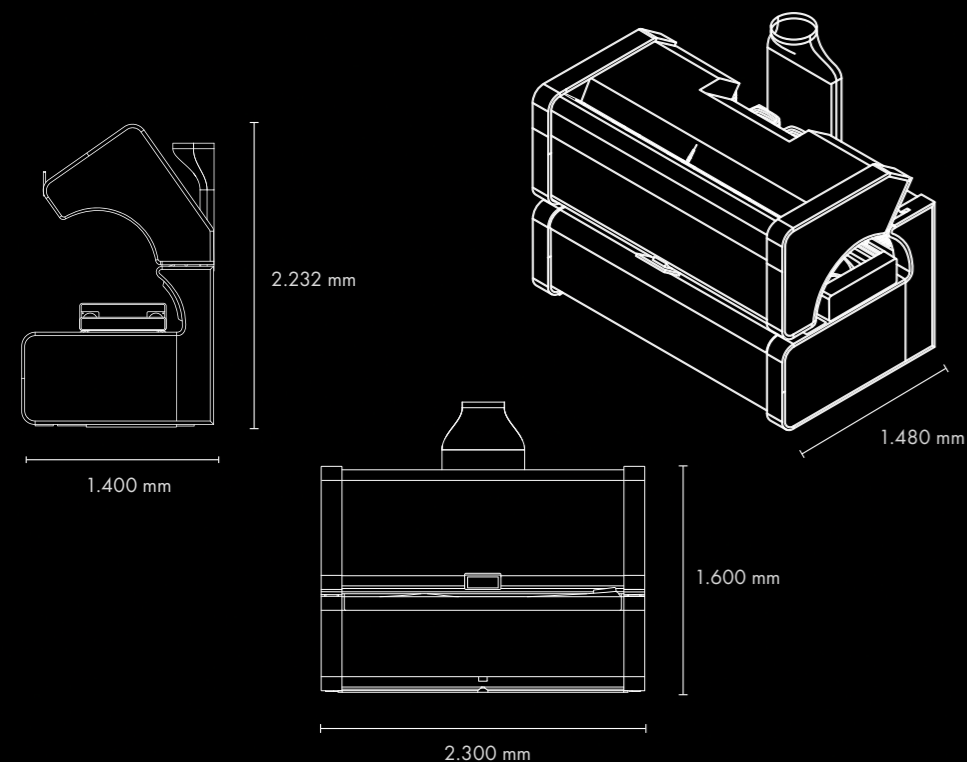

Dimensions (mm) Length x Width x Height

Closed:	2.300 mm x 1.480 mm x 1.600 mm
Open:	2.300 mm x 1.400 mm x 2.232 mm

DEVICE-SPECIFIC DATA

Maximum power consumption	12,3 kW
Maximum power consumption (without aircon)	11,0 kW

GENERAL DATA

Weight	ca. 645 kg (incl. aircon)
Bed pane max. load capacity	max. 150 kg
Bed pane dimensions	2.035 mm x 1.164 mm

Electrical data Connection

Netzspannung	400 V / ~3N / 50 Hz
Breaker	K-Automat 3-polig / 3 x 25 A mit FI (RCD)

Ambient conditions – In dry rooms (booths) with sufficient airing and ventilation

Recommended room size:	2.500 mm (Width) x 2.200 mm (Depth)
Maximum relative air humidity:	70%
Maximum room temperature:	30°C
Minimal distance to side walls:	100 mm
Minimum room height:	2.400 mm
Distance to backwall:	29 mm

“DESIGN IS COMMUNICATION.”

This is no pure styling, the process started from the technology, from the inside of the product, and evolved into a new DNA and creation of a new family of products, all recognizable and unique but all fitting each other's. The new design is pure but mostly modular, created to make every machine unique. - Etienne Salomé

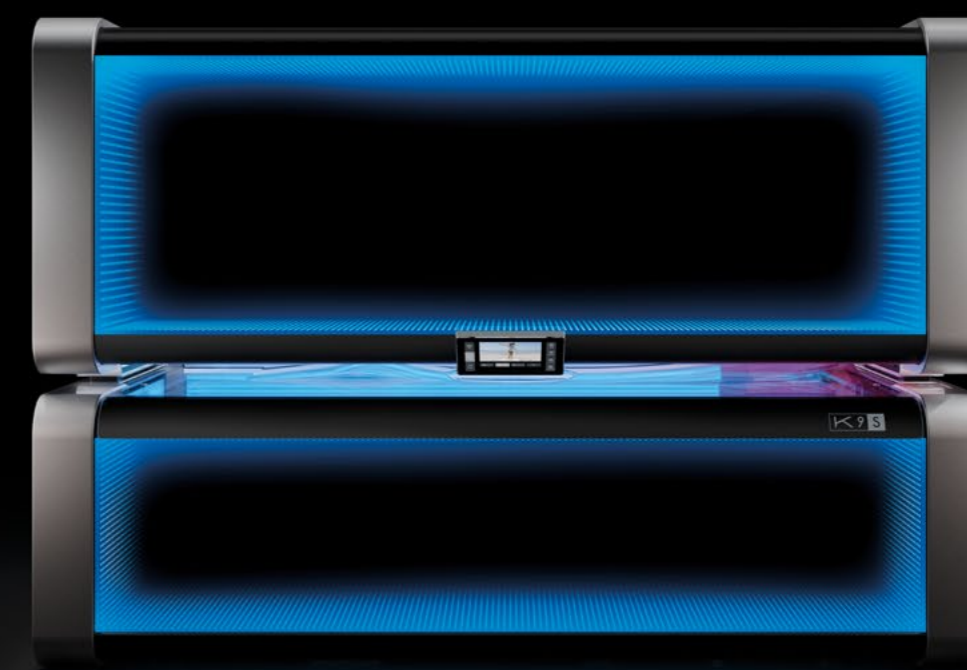

official distributor

maximus

S U N B E D S

KBL GmbH – The Beauty & Health Company · Ringstraße 24-26 · 56307 Dernbach
fon +49 (0) 26 89 - 94 26 - 0 · fax +49 (0) 26 89 - 94 26 - 66 · e-mail: info@kbl.de

www.megaSun.de



Copyright 2023 KBL GmbH, Germany

Errors and omissions possible. KBL reserves the right to change technical data or specifications without notice.

Art.-Nr. 3010170299